

Datasheet

产品名称 (Product): BLE ibeacon module

产品型号 (Model No.): Holyiot-16032-nRF52832

目录

1. Description.....	3
Hardware module :.....	3
Features :.....	3
Application:.....	4
2. Introduction.....	5
2.1 Programmer.....	5
2.2 Software development Tool.....	5
2.3 Protocols.....	5
Software Development Kit.....	5
2.4 SoftDevices.....	6
3. Product Descriptions.....	6
3.1 Mechanical drawings.....	6
3.2 Pin assignments.....	7
4. Miscellaneous.....	8
5. Absolute maximum ratings.....	8
6. List of Holyiot module.....	9

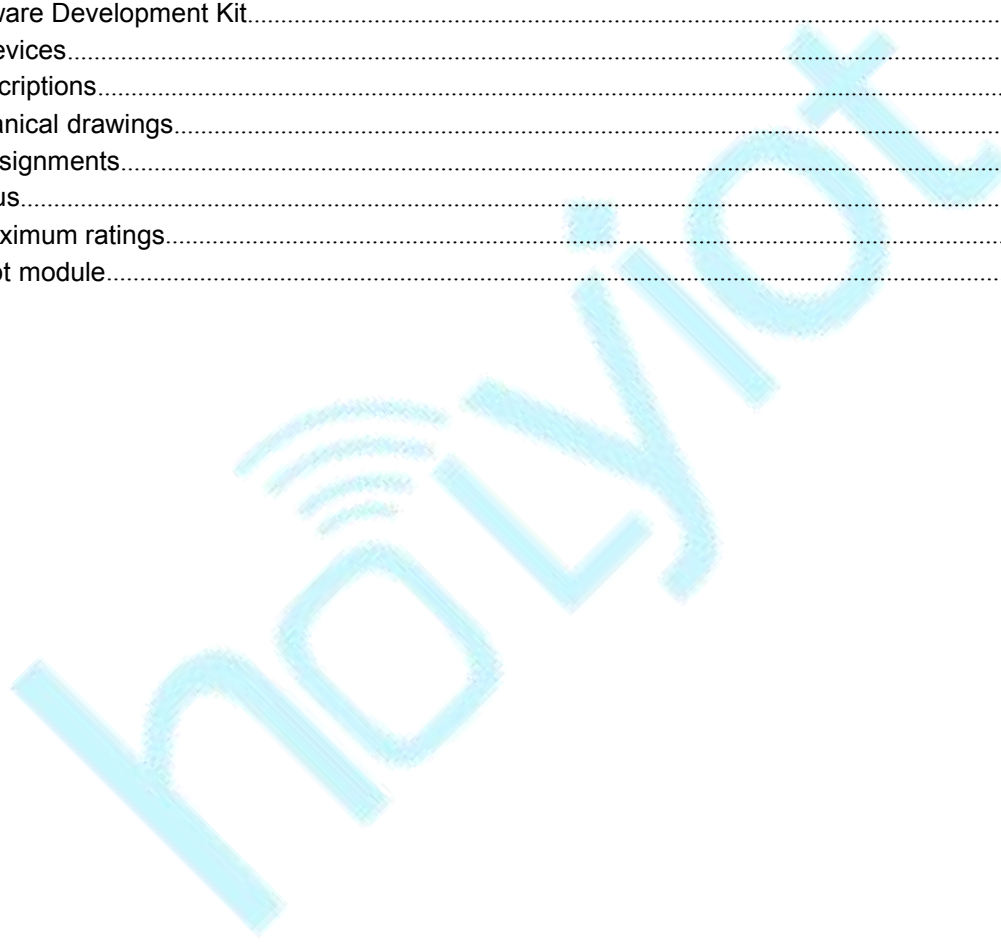

1. Description

YJ-16032 BLE module is based on Nordic nRF52832 SoC, the nRF52832 SoC is a powerful, highly flexible ultra-low power multi-protocol SoC ideally suited for Bluetooth® low energy (previously called Bluetooth Smart), ANT and 2.4GHz ultra low-power wireless applications. The nRF52832 SoC is built around a 32-bit ARM® Cortex™-M4F CPU with 512kB + 64kB RAM. The embedded 2.4GHz transceiver supports Bluetooth low energy, ANT and proprietary 2.4 GHz protocol stack. It is on air compatible with the nRF51 Series, nRF24L and nRF24AP Series products from Nordic Semiconductor.

Processing power

Multiprotocol radio (bluetooth low energy, ANT, 2.4G proprietary)

Power efficiency

Hardware module :

SWD programmer (SWDIO,SWCLK,VDD,GND)

nRF52832 QFAA

Size :40.13mm*39.62mm

Support NFC functions

BLE stack & RF 2.4Ghz

FCC certification

Features :

Single chip, highly flexible, 2.4 GHz multi-protocol SoC

32-bit ARM Cortex-M4F Processor

1.7v to 3.6v operation

512kB flash + 64kB RAM

Supports concurrent Bluetooth low energy/ANT protocol operation

Up to +4dBm output power

-96dBm sensitivity, Bluetooth low energy

Thread safe and run-time protected

Event driven API

On air compatible with nRF24L and nRF24AP series

2 data rates (2Mbps/1Mbps)

PPI - maximum flexibility for power-efficient applications and code simplification

Automated power management system with automatic power management of each peripheral

Configurable I/O mapping for analog and digital I/O

3 x Master/Slave SPI

2 x Two-wire interface (I²C)

UART (RTS/CTS)

3 x PWM

AES HW encryption

Real Time Counter (RTC)

Digital microphone interface (PDM)

On-chip balun

Application:

- Internet of Things (IoT)
- SmartHome sensors
- Computer peripherals
- A4WP 'Rezence' wireless charging
- Sports and fitness sensors and hubs
- Smart watches
- Interactive games
- Wearables
- Connected white goods
- Voice-command smart remotes
- Beacons
- Connected health products
- RC Toys
- Building automation and sensor networks

2. Introduction

YJ-16032 BLE module is based on Nordic nRF52832 SoC, the nRF52832 SoC is a powerful, highly flexible ultra-low power multi-protocol SoC ideally suited for Bluetooth® low energy (previously called Bluetooth Smart), ANT and 2.4GHz ultra low-power wireless applications. The nRF52832 SoC is built around a 32-bit ARM® Cortex™-M4F CPU with 512kB + 64kB RAM. The embedded 2.4GHz transceiver supports Bluetooth low energy, ANT and proprietary 2.4 GHz protocol stack. It is on air compatible with the nRF51 Series, nRF24L and nRF24AP Series products from Nordic Semiconductor.

Processing power

Multiprotocol radio (bluetooth low energy, ANT, 2.4G proprietary)

Power efficiency

2.1 Programmer

Holyiot-16032 module use the Serial Wire Debug(SWD port), the module which layout the SWDIO, SWCLK, VDD, GND for debug and flash your own firmware, more info about the SWD, please visit https://www.silabs.com/community/mcu/32-bit/knowledge-base.entry.html/2014/10/21/serial_wire_debugs-qKCT

You can using the Jlink or Jtag for programmer.

2.2 Software development Tool

It supports the standard Nordic Software Development Tool-chain using Segger Embedded Studio, Keil, IAR and GCC. More info please visit <https://www.nordicsemi.com/Software-and-Tools/Development-Tools>

2.3 Protocols

This module support Bluetooth 5, Bluetooth Low Energy,Bluetooth mesh,Thread,802.15.4,ANT, 2.4GHz proprietary. So we can use different protocols for different situations.

Software Development Kit

Nordic Semiconductor's Software Development Kits (SDK) are your starting point for software development on the nRF51 and nRF52 Series. It contains source code libraries and example

applications covering wireless functions, libraries for all peripherals, bootloaders, wired and OTA FW upgrades, RTOS examples, serialization libraries.

More info please visit <https://www.nordicsemi.com/Software-and-Tools/Software/nRF5-SDK>

You can also download the SDK for coding development .

2.4 SoftDevices

Nordic Semiconductor protocol stacks are known as SoftDevices. SoftDevices are pre-compiled, pre-linked binary files. SoftDevices can be programmed in nRF5 series devices, and are freely downloadable from the Nordic website. Please download that here:

<https://www.nordicsemi.com/Software-and-Tools/Software/S132>

Over-The-Air DFU

The SoC is supported by an Over-The-Air Device Firmware Upgrade (OTA DFU) feature. This allows for in the field updates of application software and SoftDevice.

3. Product Descriptions

3.1 Mechanical drawings

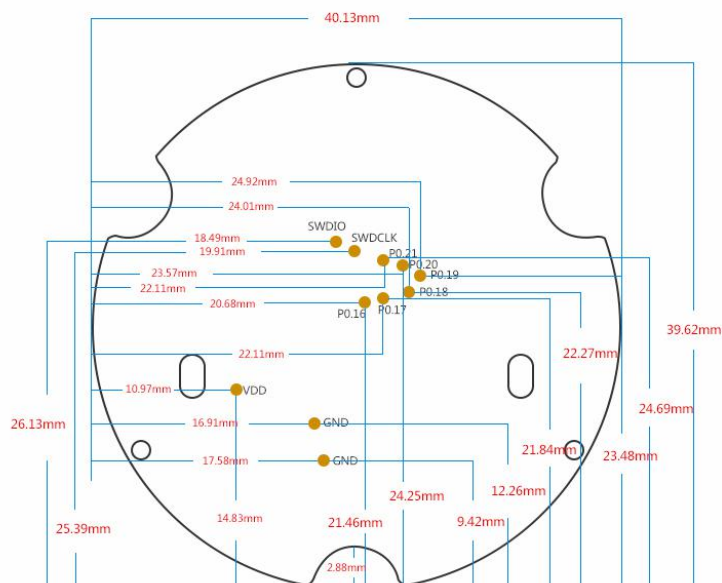

3.2 Pin assignments

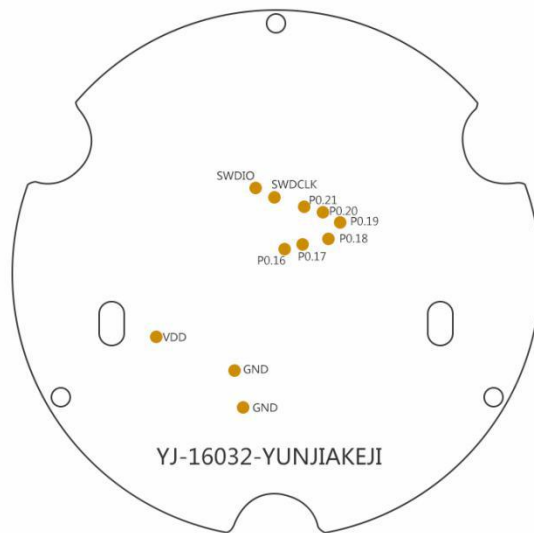

PIN No.	PIN define	Functions
1	VDD	Power
2	GND	Ground
3	GND	Ground
4	SWDIO	Digital input(serial wire debug)
5	SWCLK	Digital I/O ² (serial wire debug)
6	P0.21 (Reset)	Digital I/O(general purpose I/O ² Configure as the Pins reset
7	P0.20 Traceclk	Digital I/O(general purpose I/O Trace port clock output
8	P0.19	Digital I/O(general purpose I/O
9	P0.18 TRACEDATA[0] / SWO	Digital I/O(general purpose I/O Single wire output, Trace port output
10	P0.17	Digital I/O(general purpose I/O
11	P0.16 TRACEDATA[1]	Digital I/O(general purpose I/O Trace port output

4. Miscellaneous

Soldering Temperature-Time Profile for Re-Flow Soldering. Maximum number of cycles for re-flow is 2. No opposite side re-flow is allowed due to module weight.

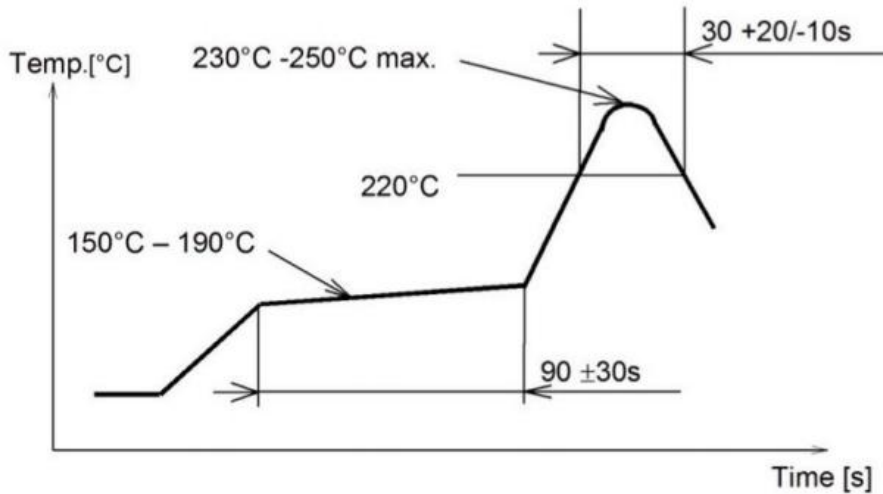

5. Absolute maximum ratings

Maximum ratings are the extreme limits to which the chip can be exposed for a limited amount of time without permanently damaging it. Exposure to absolute maximum ratings for prolonged periods of time may affect the reliability of the device.





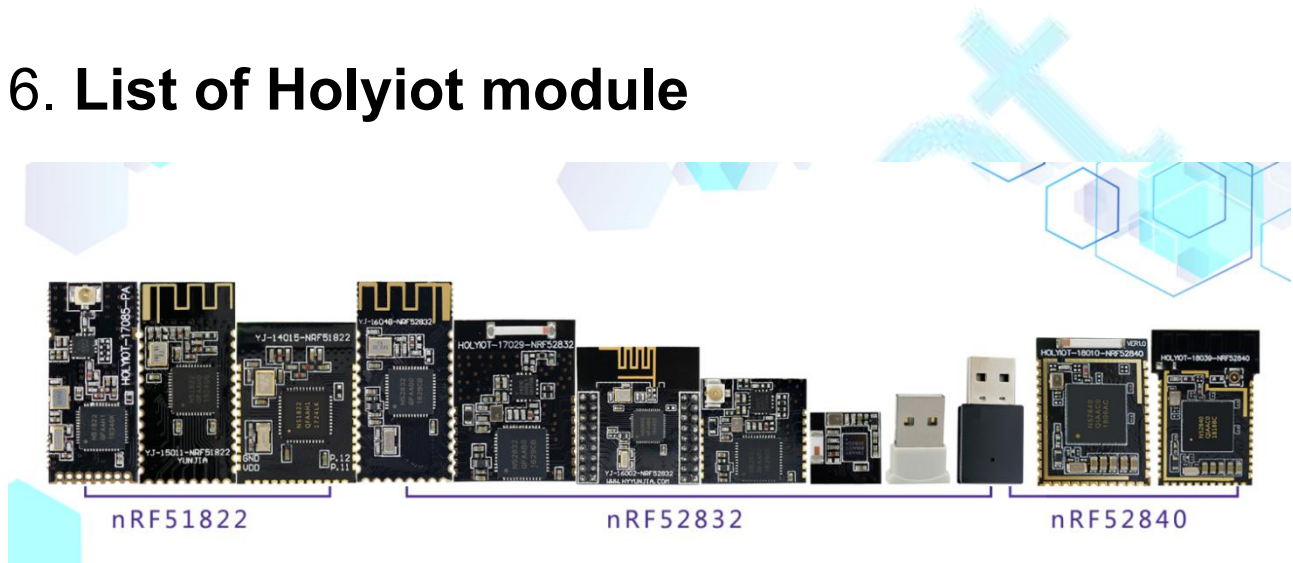

Absolute maximum ratings:

	Min.	Max.	Unit
Supply voltages			
VDD	-0.3	+3.9	V
VSS		0	V
I/O pin voltage			
V _{IO} , VDD ≤ 3.6 V	-0.3	VDD + 0.3 V	V
V _{IO} , VDD > 3.6 V	-0.3	3.9 V	V
NFC antenna pin current			
I _{NFC1/2}		80	mA
Radio			
RF input level		10	dBm
Environmental QFN48, 6×6 mm package			
Storage temperature	-40	+125	°C
MSL (moisture sensitivity level)		2	
ESD HBM (human body model)		4	kV
ESD CDM (charged device model)		1000	V
Environmental WLCSP, 3.0×3.2 mm package			
Storage temperature	-40	+125	°C
MSL		1	
ESD HBM		2	kV
ESD CDM		500	V
Flash memory			
Endurance	10 000		Write/erase cycles
Retention	10 years at 40°C		





6. List of Holyiot module



Part No.	Nordic chip	Holyiot No.	PA	Antenna	Picture
1	nRF51822	Holyiot-17085-PA	✓	IPX antenna	 
2	nRF51822	YJ-15011-nRF51822	×	PCB antenna	 
3	nRF51822	YJ-14015-nRF51822	×	PCB antenna	 

4	nRF52832	YJ-16048-nRF52832	×	PCB antenna	 
5	nRF52832	YJ-17029-nRF52832	✓	Ceramic antenna	 
6	nRF52832	YJ-16002-nRF52832	×	PCB antenna	 
7	nRF52832	YJ-17024-nRF52832	✓	IPX antenna	 
8	nRF52832	YJ-17095-nRF52832	×	Ceramic antenna	 
9	nRF52832	YJ-17017-USB	×	Ceramic antenna	 
10	nRF52832	YJ-17076-USB	×	PCB antenna	 
11	nRF52840	YJ-17120-USB	×	PCB antenna	 

12	nRF52840	YJ-18010-nRF52840	×	Ceramic antenna	 holyiot
13	nRF52840	YJ-18039-nRF52840	×	IPX antenna & PCB antenna	 holyiot

holyiot